

Vectron International

Filter specification

TFS 1575H

1/5

Measurement condition

Ambient temperature: 23 °C
 Input power level: 0 dBm
 Terminating impedance: *
 Input: 403,13 Ω || -1,21 pF
 Output: 375,40 Ω || -1,26 pF

Characteristics

Remark:

The minimum attenuation in the pass band is defined as the insertion loss a_e . The nominal frequency f_N is fixed at 1575,42 MHz without any tolerance or limit. The values of absolute attenuation a_{abs} are guaranteed for the whole operating temperature range. The frequency shift of the filter in the operating temperature range is included in the production tolerance scheme.

D a t a		typ. value		tolerance / limit	
Insertion loss	a_e	3,0	dB	max.	5,0 dB
Nominal frequency	f_N	-			1575,42 MHz
Passband		-		$f_N \pm$	1,4 MHz
Pass band ripple		0,7	dB	max.	1,5 dB
Bandwidth					
3	dB	6,3	MHz	min.	3,5 MHz
Absolute attenuation	a_{abs}				
1500	MHz ... 1530 MHz	40,6	dB	min.	30 dB
1530	MHz ... 1560 MHz	29,4	dB	min.	20 dB
1585	MHz ... 1620 MHz	37	dB	min.	20 dB
1620	MHz ... 1630 MHz	34	dB	min.	30 dB
1630	MHz ... 1710 MHz	37	dB	min.	35 dB
VSWR within PB		1,8	: 1	max.	2,2 : 1
Input power level		-		max.	10 dBm
Operating temperature range	OTR	-			- 40 °C ... + 85 °C
Storage temperature range		-			- 45 °C ... + 90 °C
Temperature coefficient of frequency	TC_f **	- 0,051	ppm/K ²		-

*) The terminating impedances depend on parasitics and q-values of matching elements and the board used, and are to be understood as reference values only. Should there be additional questions do not hesitate to ask for an application note or contact our design team.

***) $\Delta f_c(\text{Hz}) = TC_f(\text{ppm/K}^2) \times (T - T_0)^2 \times f_{CAT}(\text{MHz})$.

Generated:

Checked / Approved:

Vectron International GmbH & Co. KG
 Potsdamer Straße 18
 D 14 513 TELTOW / Germany
 Tel: (+49) 3328 4784-0 / Fax: (+49) 3328 4784-30
 E-Mail: tft@vectron.com

Vectron International GmbH & Co. KG reserves the right to make changes to the product(s) and/or information contained herein without notice. No liability is assumed as a result of their use or application. No rights under any patent accompany the sale of any such product(s) or information.

Filter characteristic

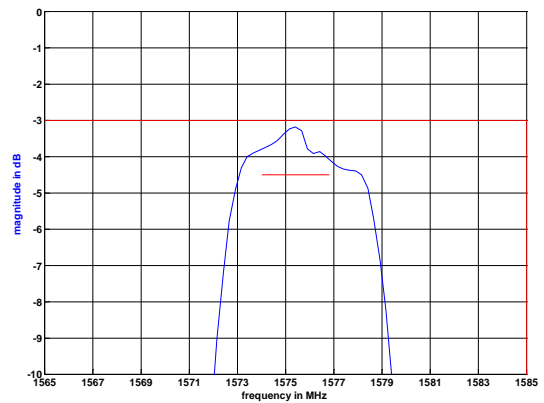
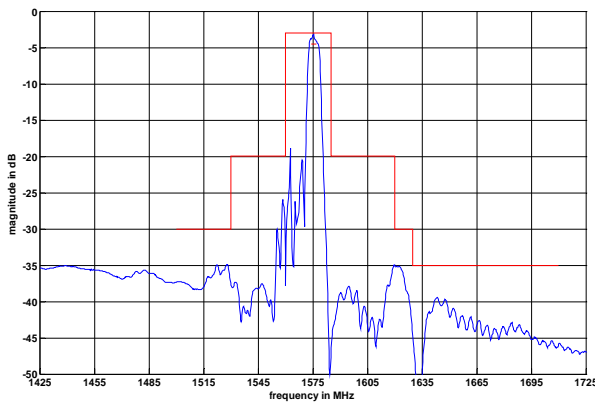

Construction and pin connection

(All dimensions in mm)

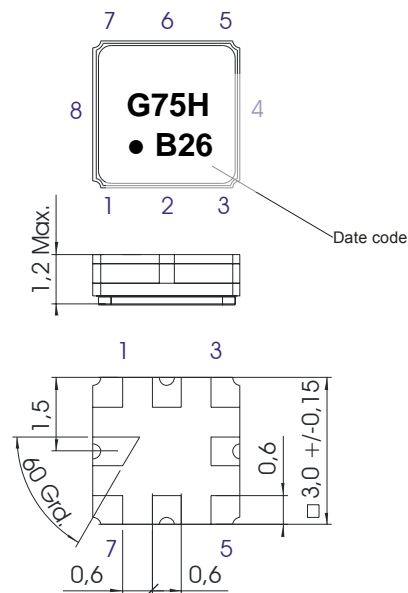

- 1 Ground
- 2 Input
- 3 Ground
- 4 Ground
- 5 Ground
- 6 Output
- 7 Ground
- 8 Ground

- Date code: Year + week
- B 2011
 - C 2012
 - D 2013
 - ...

50 Ohm Test circuit

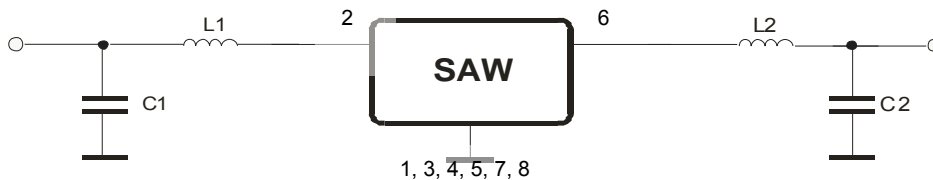

Vectron International GmbH & Co. KG
 Potsdamer Straße 18
 D 14 513 TELTOW / Germany
 Tel: (+49) 3328 4784-0 / Fax: (+49) 3328 4784-30
 E-Mail: tft@vectron.com

Vectron International GmbH & Co. KG reserves the right to make changes to the product(s) and/or information contained herein without notice. No liability is assumed as a result of their use or application. No rights under any patent accompany the sale of any such product(s) or information.

Stability characteristics, reliability

After the following tests the filter shall meet the whole specification:

1. Shock: 500g, 1 ms, half sine wave, 3 shocks each plane;
DIN IEC 68 T2 - 27
2. Vibration: 10 Hz to 500 Hz, 0,35 mm or 5 g respectively, 1 octave per min, 10 cycles per plan, 3 plans;
DIN IEC 68 T2 - 6
3. Change of temperature: -55 °C to 125°C / 30 min. each / 10 cycles
DIN IEC 68 part 2 – 14 Test N
4. Resistance to solder heat (reflow): reflow possible: three times max.;
for temperature conditions refer to the attached "Air reflow temperature conditions" on page 4;

This filter is RoHS compliant (2002/95/EG, 2005/618/EG)

Packing

Tape & Reel: IEC 286 – 3, with exception of value for N and minimum bending radius;
tape type II, embossed carrier tape with top cover tape on the upper side;

max. pieces of filters per reel:	9000
reel of empty components at start:	min. 300 mm
reel of empty components at start including leader:	min. 500 mm
trailer:	min. 300 mm

Tape (all dimensions in mm)

- W : 8,00 ± 0,3
- Po : 4,00 ± 0,1
- Do : 1,50 +0,1/-0
- E : 1,75 ± 0,1
- F : 3,50 ± 0,05
- G(min) : 0,75
- P2 : 2,00 ± 0,05
- P1 : 4,00 ± 0,1
- D1(min) : 1,50
- Ao : 3,25 ± 0,1
- Bo : 3,25 ± 0,1
- Ct : 5,5 ± 0,1

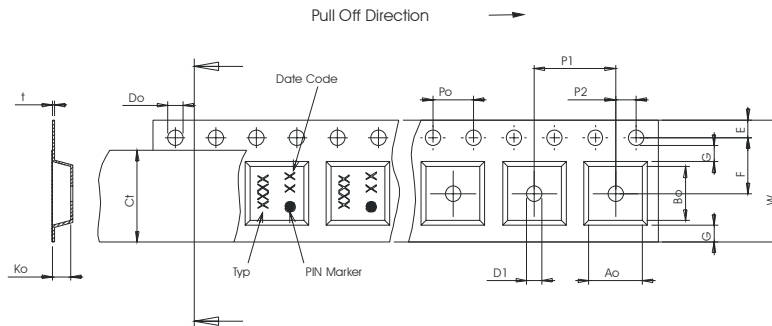

Reel (all dimensions in mm)

- A : 330
- W1 : 8,4 +1,5/-0
- W2(max) : 14,4
- N(min) : 50
- C : 13,0 +0,5/-0,2

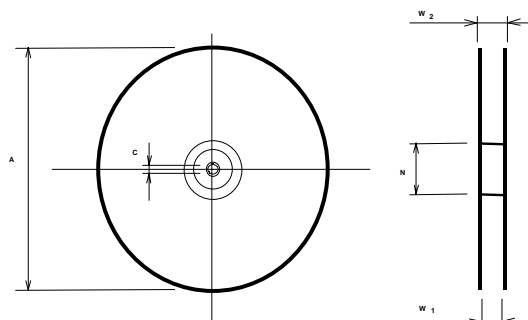

The minimum bending radius is 45 mm.

Vectron International GmbH & Co. KG
Potsdamer Straße 18
D 14 513 TELTOW / Germany
Tel: (+49) 3328 4784-0 / Fax: (+49) 3328 4784-30
E-Mail: tft@vectron.com

Vectron International GmbH & Co. KG reserves the right to make changes to the product(s) and/or information contained herein without notice. No liability is assumed as a result of their use or application. No rights under any patent accompany the sale of any such product(s) or information.

Air reflow temperature conditions

Conditions	Exposure
Average ramp-up rate (30°C to 217°C)	less than 3°C/second
> 100°C	between 300 and 600 seconds
> 150°C	between 240 and 500 seconds
> 217°C	between 30 and 150 seconds
Peak temperature	max. 260°C
Time within 5°C of actual peak temperature	between 10 and 30 seconds
Cool-down rate (Peak to 50°C)	less than 6°C/second
Time from 30°C to Peak temperature	no greater than 300 seconds

Chip-mount air reflow profile

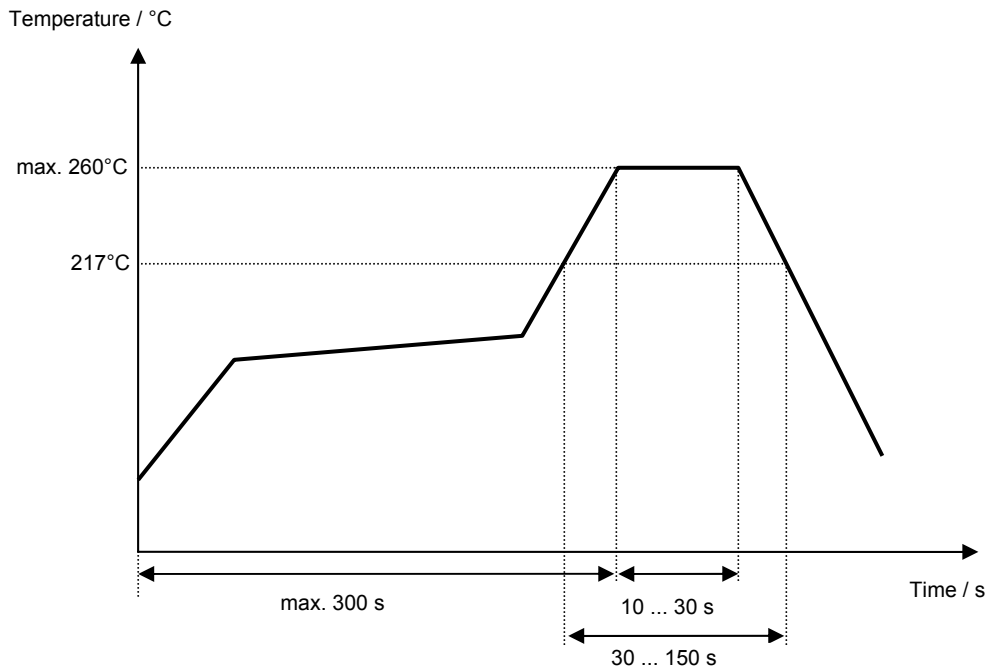

Vectron International GmbH & Co. KG
 Potsdamer Straße 18
 D 14 513 TELTOW / Germany
 Tel: (+49) 3328 4784-0 / Fax: (+49) 3328 4784-30
 E-Mail: tft@vectron.com

Vectron International GmbH & Co. KG reserves the right to make changes to the product(s) and/or information contained herein without notice. No liability is assumed as a result of their use or application. No rights under any patent accompany the sale of any such product(s) or information.

History

Version	Reason of Changes	Name	Date
1.0	- Generation of development specification	S. Sabah	06.09.2005
1.1	- Add typ. value and filter characteristic - Change stability characteristics and generation of filter specification	Strehl	05.04.2006
2.0	- adjust insertion loss, VSWR, passband ripple, stopband attenuation - typo in terminating impedance corrected	Steiner	19.02.2010
3.0	- adjust insertion loss, terminating impedance and correct pinning	S. Channaa	28.06.2011