

Typical Applications

Base Stations
 Test Equipment
 Switching
 Portable Equipment

Features

Surface Mount Package
 Reflow Process Compatible
 AT-Cut Crystal
 Low Phase Noise
 Tight Stability



Frequency range

1 MHz – 700 MHz

Standard frequencies

2.048; 10; 13; 16.384; 30.720; 32.768; 38.880; 44.8 MHz
 51.840; 52.00; 58.9824; 61.44; 68.736; 77.760; 76.8 MHz
 81.92; 92.16; 100; 112; 122.88; 125; 134.4; 153.6; 155.52 MHz
 156.25; 160; 179.2; 184.32; 245.76; 312.5; 320; 368.64 MHz
 400; 448; 491.52; 622.08; 672 MHz

Frequency stabilities¹

Parameter	Min	Typ	Max.	Units	Operating temp range	Ordering Code ⁵
vs. operating temperature range (Referenced to +25°C)	-15.0		+15.0	ppm	-20 ... +70°C	D105
Parameter	Min	Typ	Max.	Units	Condition	
Initial tolerance	-10.0		+10.0	ppm	@vc=Vs/2	
vs. supply voltage change	-3.0		+3.0	ppm	Vs ± 5%	
vs. load change	-1.0		+1.0	ppm	Load ± 10%	
vs. aging /1. Year	-3.0		+3.0	ppm		
vs. aging / year (following Years)	-1.0		+1.0	ppm		

Frequency stabilities¹

Parameter	Min	Typ	Max.	Units	Operating temp range	Ordering Code ⁵
vs. operating temperature range (Referenced to +25°C)	-30.0		+30.0	ppm	-40 ... +85°C	F305
Parameter	Min	Typ	Max.	Units	Condition	
Initial tolerance	-15.0		+15.0	ppm	@vc=Vs/2	
vs. supply voltage change	-3.0		+3.0	ppm	Vs ± 5%	
vs. load change	-2.0		+2.0	ppm	Load ± 10%	
vs. aging /1. Year	-3.0		+3.0	ppm		
vs. aging / year (following Years)	-1.0		+1.0	ppm		

Supply voltage

Parameter	Min	Typ	Max.	Units	Condition	Ordering Code ⁵
Supply voltage (Vs)	4.75	5.0	5.25	VDC		SV050
Current consumption			40	mA	@ HCMOS	
Current consumption			90	mA	@ PECL	
Supply voltage (Vs)	3.135	3.3	3.465	VDC		SV033
Current consumption			30	mA	@ LVHCMOS	
Current consumption			80	mA	@ LVPECL	
Current consumption			25	mA	@ LVDS	

RF output

Parameter	Min	Typ	Max.	Units	Condition	Ordering Code ⁵
Signal	HCMOS					RFH
Load		15.0		pF	@ 15 pF 10 to 90 % @ Vs/2	
Rise and Fall time			5	ns		
Duty cycle	40		60	%		
Signal	PECL					RFP
Load		50		Ω	Vs - 2V 20 to 80 %	
Rise and Fall time			1	ns		
Duty cycle	45		55	%		
Signal	LVDS					RFL
Load		100		Ω	10 to 90 %	
Rise and Fall time			1	ns		
Duty cycle	40		60	%		
Signal	Sinewave					RFS
Load		50		Ω		
Output Power	-3	0	3	dBm		

Frequency Tuning (EFC)

Parameter	Min	Typ	Max.	Units	Condition
Tuning Range	± 75.0 ± 100.0	± 90.0 ± 140.0	+200.0 ± 200.0	ppm ppm	Frequency > 40MHz Frequency < 40MHz
Linearity			10	%	
Tuning Slope	Positive				
Control Voltage Range	0.0 0.5	1.65 2.5	3.3 4.5	VDC VDC	with Vs=3.3VDC with Vs=5.0VDC
Frequency control input impedance	10			k Ω	

Additional parameters

Parameter	Min	Typ	Max.	Units	Condition
Phase Noise		-85		dBc/Hz	10 Hz @52 MHz
		-115		dBc/Hz	100 Hz HCMOS
		-138		dBc/Hz	1 kHz 3,3V
		-153		dBc/Hz	10 kHz
		-155		dBc/Hz	100 kHz
Jitter		0,3		ps RMS	@ 12 kHz to 20 MHz
Phase Noise		-80		dBc/Hz	10 Hz @155,52 MHz
		-105		dBc/Hz	100 Hz PECL
		-135		dBc/Hz	1 kHz 3,3V
		-143		dBc/Hz	10 kHz
		-143		dBc/Hz	100 kHz
Jitter		0,6		ps RMS	@ 12 kHz to 20 MHz
Phase Noise		-80		dBc/Hz	10 Hz @155,52 MHz
		-112		dBc/Hz	100 Hz LVDS
		-130		dBc/Hz	1 kHz 3,3V
		-150		dBc/Hz	10 kHz
		-155		dBc/Hz	100 kHz
Jitter		0,2		ps RMS	@ 12 kHz to 20 MHz

Phase Noise	-55	dBc/Hz	10 Hz	@622,08 MHz
	-85	dBc/Hz	100 Hz	PECL
	-115	dBc/Hz	1 kHz	3,3V
	-140	dBc/Hz	10 kHz	
	-150	dBc/Hz	100 kHz	
Jitter	0,1	ps RMS	@ 12 kHz to 20 MHz	
Weight		2	g	
Processing & Packing	handling&processing note			

Enclosures

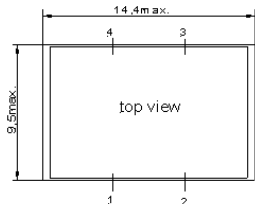
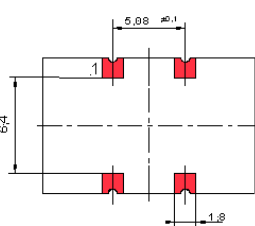
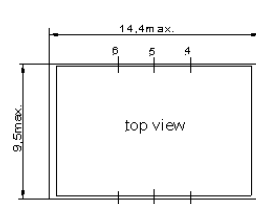
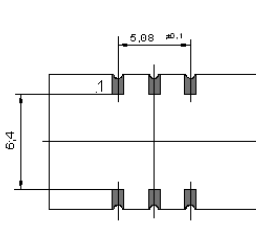
Type G223B for HCMOS Version			Type G218B for HCMOS, PECL; LVPECL and LVDS Version		
Package Codes:					
Code A1	Height "H" 5,9	Pin Length "L" NA	Code B1	Height "H" 5,9	Pin Length "L" NA
 <p>top view</p> <p>G 223 H = 5,9 ; G223 B</p>  <p>Padvorschlag land pattern recomm endation</p>			 <p>top view</p> <p>G 218 H = 5,9 ; G218 B H = 2,8 ; G218 C</p>  <p>Padvorschlag land pattern recomm endation</p>		
Dimensions: mm			Dimensions: mm		

Pin Connections	Pin Connections				
1 Control Voltage (Vc) 2 Ground (Case) 3 RF Output 4 Supply Voltage Input (Vs) Outline Drawing: G223B	1 Control Voltage (Vc) 2 N/C / Enable (optional) 3 Ground (Case) 4 RF Output 5 Complementary RF Output / (N/C: HCMOS only) 6 Supply Voltage Input (Vs) Outline Drawing: G218B				
	Enable true table	HCMOS		LVPECL / LVDS	
	Pin 2	Pin 4	Pin 5	Pin 4	Pin 5
	High	Data	N/C	No Data	No Data
	Open	Data	N/C	Data	compl. Data
	Low	High Tristate	N/C	Data	compl. Data

Marking

C5310A1-xxxx
 frequency
 * VI AYYWW

Absolute Maximum Ratings

Parameter	Min	Typ	Max.	Units	Condition
Supply voltage (Vs)			7	V	
Operable temperature range	-30		+80	°C	
Storage temperature range	-40		+90	°C	

Typical Phase Noise and Jitter

(52 MHz; HCMOS output)

C5310A1-0113

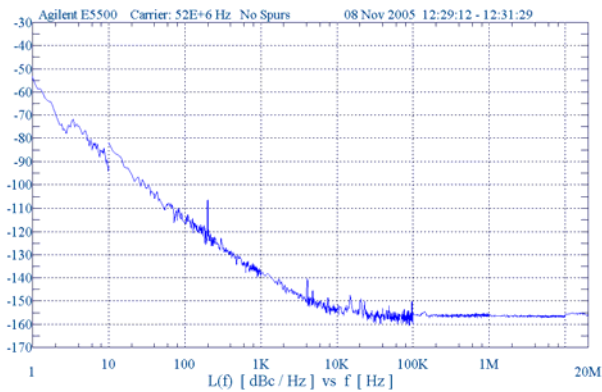

Frequency range [Hz]	S ϕ (f) [dB]	Jitter [ps rms]
100Hz to 1.5MHz	-77dB	0.432ps
50kHz to 1.5MHz	-91dB	0.086ps
12kHz to 20MHz	-80dB	0.306ps

(155,52 MHz; PECL output)

C5310A1-0076 – 155.52 MHz

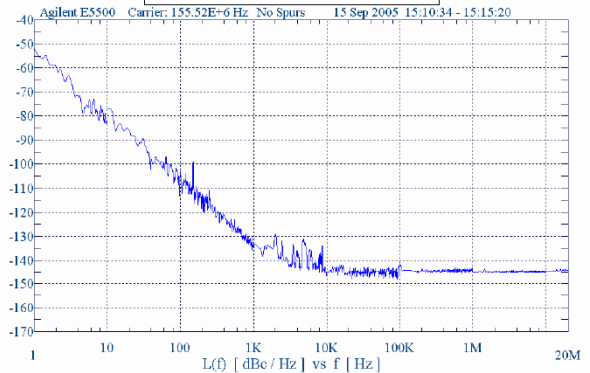

Frequency range [Hz]	S ϕ (f) [dB]	Jitter [ps rms]
500Hz to 1.5MHz	-73.96dB	0.205ps
65kHz to 1.5MHz	-75.87dB	0.165ps
12kHz to 20MHz	-65.34dB	0.553ps

Typical Phase Noise and Jitter

(155,52MHz; LVDS output)

C5310A1-0103

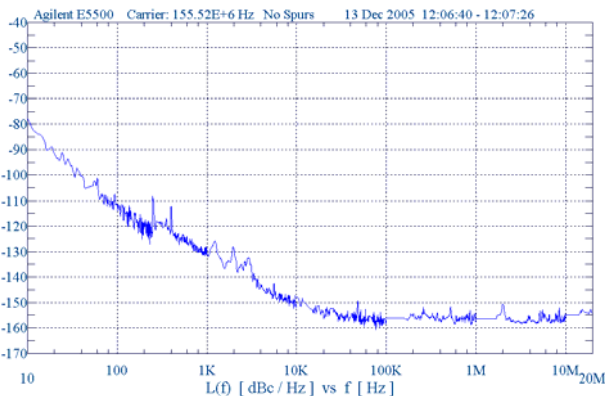

Frequency range [Hz]	S ϕ (f) [dB]	Jitter [ps rms]
100Hz to 1.5MHz	-83dB	0.072ps
50kHz to 1.5MHz	-88dB	0.041ps
12kHz to 20MHz	-76dB	0.162ps

(622,08MHz; PECL output)

C5310A1-0096

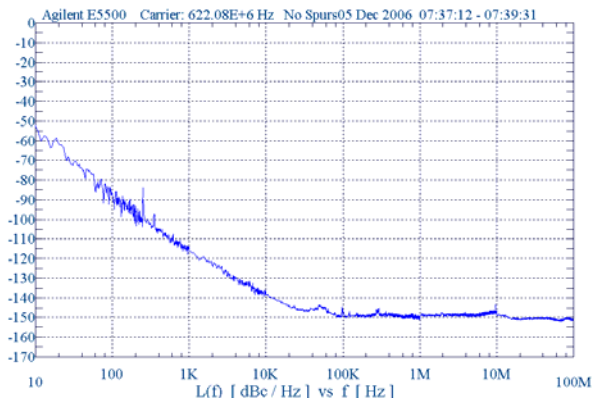

Frequency range [Hz]	S ϕ (f) [dB]	Jitter [ps rms]
1kHz to 5MHz	-75dB	0.048ps
250kHz to 5MHz	-76dB	0.041ps
12kHz to 20MHz	-70dB	0.082ps

Typical tuning slope

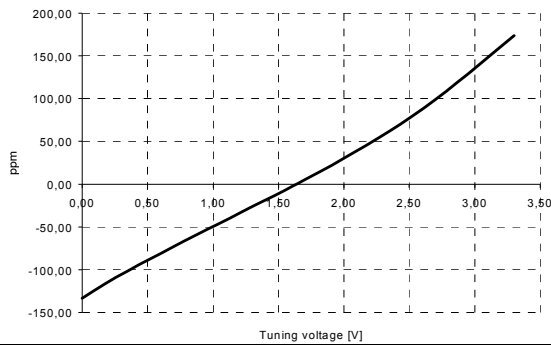

Typical frequency stability vs tp

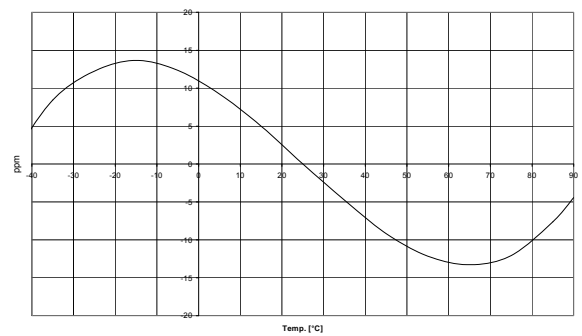

Standard Shipping Method

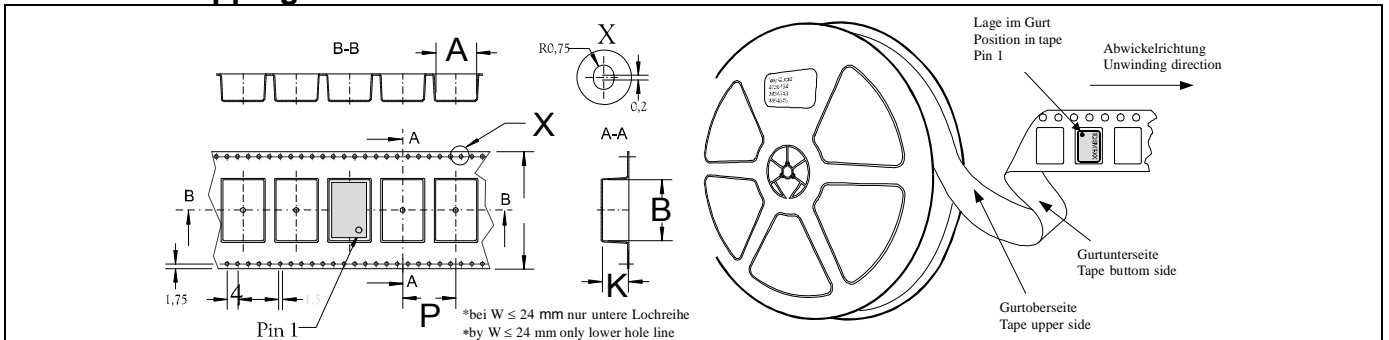

Enclosure Type | **Tape width W [mm]** | **Quantity per meter** | **Quantity per reel** | **Dimension P** | Production tolerance complying DIN IEC 286-3

G218B / G223B	24	83,3	850	12	
---------------	----	------	-----	----	--

Recommended Reflow Profile

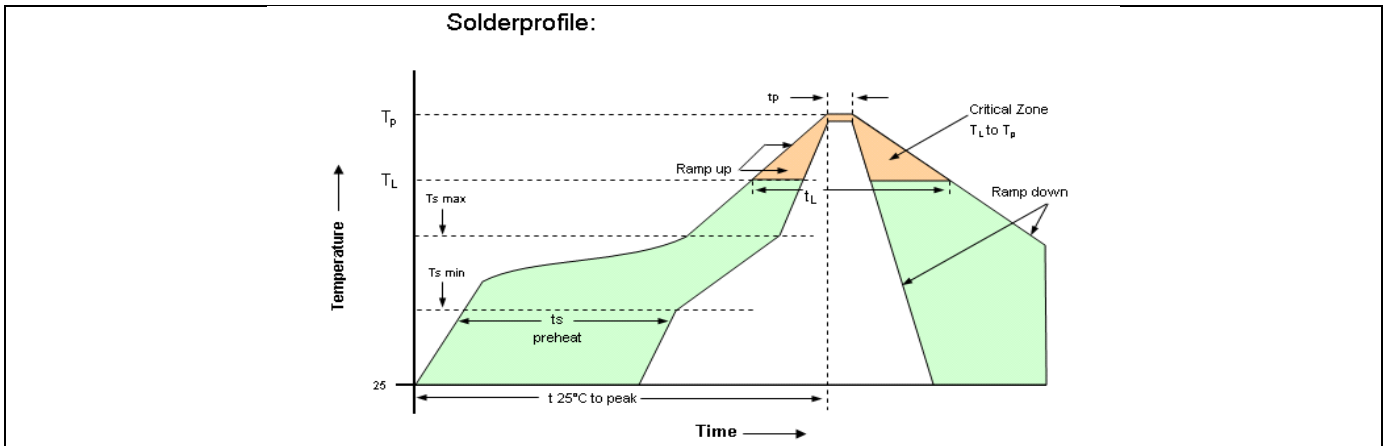

Profile Feature	Pb-Free Assembly /Sn-Pb Assembly	Profile Feature	Pb-Free Assembly /Sn-Pb Assembly
Average ramp-up rate (T _L to T _p)	3°C/second max.	Time 25°C to Peak Temperature	8 minutes max.
Preheat -Temperature Min T _{Smin}) -Temperature Min T _{Smax}) -Time (min to max) (ts)	150°C 200°C 60-180 seconds	Time maintained above - Temperature (T _L) - Time (t _L)	217°C 60-150 seconds
T _{Smax} to T _L - Ramp-up Rate	3°C/second max.		
Time maintained above - Temperature (T _L) - Time (t _L)	217°C 60-150 seconds	Time within 5°C of actual Peak Temperature (tp)	20-40 seconds
Peak Temperature (T _p)	max 260°C	Ramp-down Rate	6°C/second max.

Note: All temperatures refer to topside of the package, measured on the package body surface. SMD oscillators must be on the top side of the PCB during the reflow process.

How to Order this Product:

Model	Stability Code	Supply Voltage Code	RF Output Code	Package Code	Frequency Control / Enable	Frequency
C5310	D105	SV050	RFH	A1		

vs.operat. temp. range:

D105: ±15ppm -20 ... +70°C
 F305: ±30ppm -40 ... +85°C

Supply:

SV050: 5V
 SV033: 3.3V

Signal:

RFH: HCMOS
 RFP: PECL
 RFL: LVDS

Enclosures:

A1: H: 5.9 L: NA
 B1: H: 5.9 L: NA

Dimension: mm