



# OCXO: Oven Controlled Crystal Oscillator

## Introduction

If stability requirements are too stringent to be met by a basic crystal oscillator or TCXO, the crystal and critical circuits may be temperature controlled by an oven. The block diagram for a Vectron oven controlled crystal oscillator is similar to that for a Vectron TCXO except that the varactor diode and associated thermistor compensation network are deleted and the oscillator is instead temperature controlled by a proportionally controlled oven.

## Proportional Oven Controlled

A proportional control is an electronic servo system which continuously supplies power to the oven; it varies the amount of oven power, continuously compensating for the ambient temperature changes. In many Vectron oven controlled oscillators, a thermistor is heat sunk to the oven's metal shell to sense temperature. The thermistor is one leg of a resistance bridge, as shown in the following diagram.

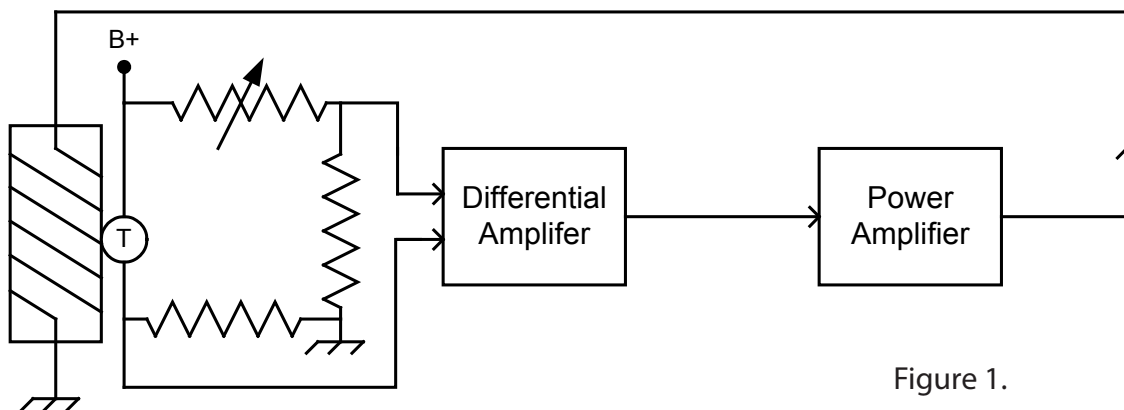

Figure 1.

The bridge operates such that if the temperature at the oven decreases due to an ambient temperature change, the change in thermistor resistance causes the bridge to unbalance, developing an increase in bridge output voltage. This voltage is amplified in a high-gain differential amplifier. The output of the differential amplifier is further amplified in a power amplifier which drives directly into the oven winding. Thus, the small voltage increase resulting from bridge unbalance generates a large voltage increase across the oven winding. This increase in power to the oven generates more heat, compensating for the temperature decrease which was initially sensed by the thermistor. Similarly, an increase in temperature at the oven causes a reduction in bridge output voltage, which results in reduced power into the oven and a compensating temperature decrease.

An alternative to this design, used in some Vectron OCXOs, has the power amplifier(s) heat sunk to the oven shell as the heat transfer mechanism, in lieu of having a heater winding. The concept is the same, the only difference being the vehicle by which the heat is applied to the oven.

Employing a proportionally controlled oven can improve oscillator temperature stability relative to the crystal's inherent stability by more than 5000 times (from  $\pm 1 \times 10^{-5}$  to  $\pm 1 \times 10^{-9}$  over 0-50°C, for example). However, the oven control system is not perfect because (a) the open loop gain is not infinite, (b) there are internal temperature gradients within the oven and (c) circuitry outside the oven which is subjected to ambient temperature changes can "pull" the frequency. Therefore, a change in ambient temperature will result in small changes in oven temperature.

## Setting Oven Temperature

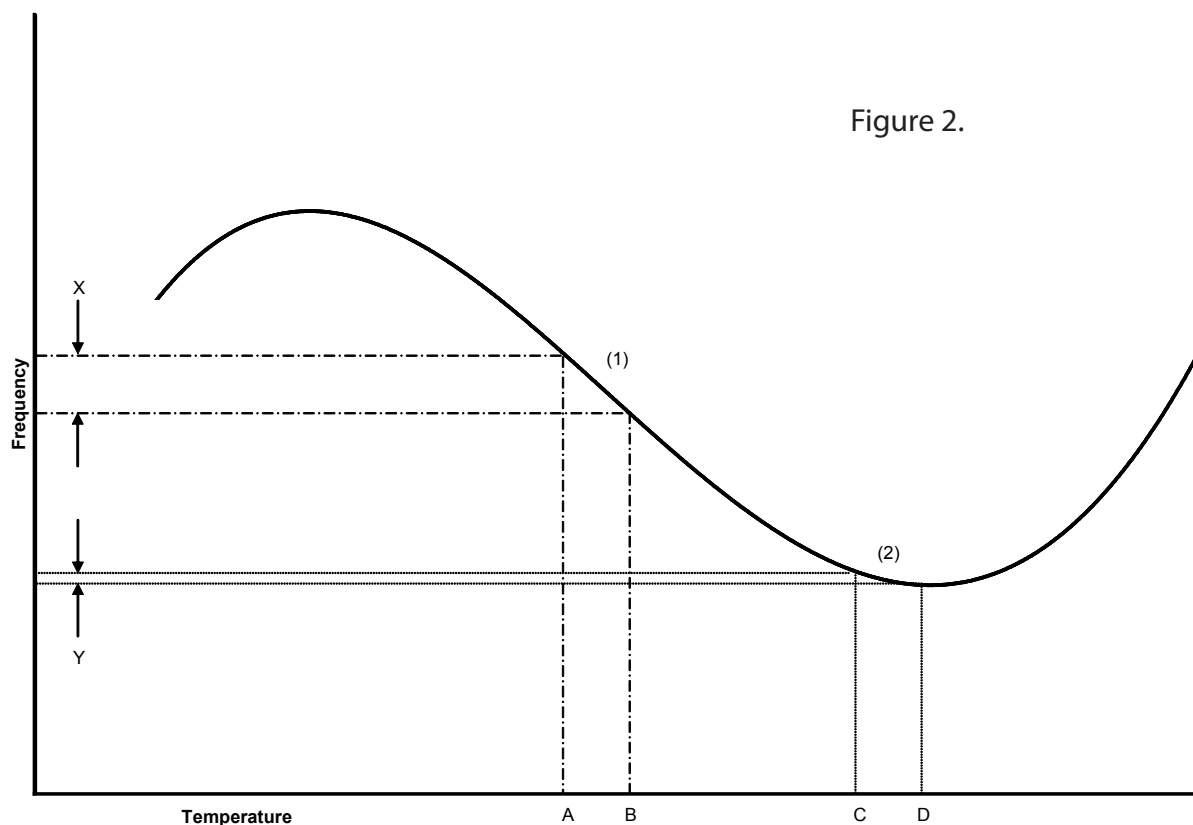

As shown above, the actual temperature to which the oven is set is critical in minimizing the effect of ambient temperature change.

Referring to Figure 2, if the oven temperature were set to the point designated as (1), and a change in ambient temperature caused a change in oven temperature from A to B, a frequency change of magnitude X would result. However, if the oven temperature were set to the upper turnover point (2), an equal temperature change (C to D) would result in a significantly reduced change in frequency (magnitude Y). Therefore, each Vectron oven is individually set to the turnover temperature of the crystal which it houses. This is accomplished by adjusting the potentiometer shown as one leg of the bridge in Figure 1.

## Warmup with AT cut crystals

When an oscillator is initially turned on at room temperature the frequency is extremely high relative to the output frequency after the oven stabilizes, typically by  $30 \times 10^{-6}$ . This is simply due to the fact that the frequency of an AT cut crystal is considerably higher at room temperature than at its upper turnover temperature. As the oven warms up, the crystal frequency rapidly decreases. In standard Vectron oscillators, the oven balances in 10-15 minutes but the crystal displays a rubberband effect and overshoots its final frequency per Figure 3, prior to stabilizing. Typically, relatively high degree of stability is achieved within 30 minutes after turn-on; this time can be reduced to less than 5 minutes in special fast warm-up designs.

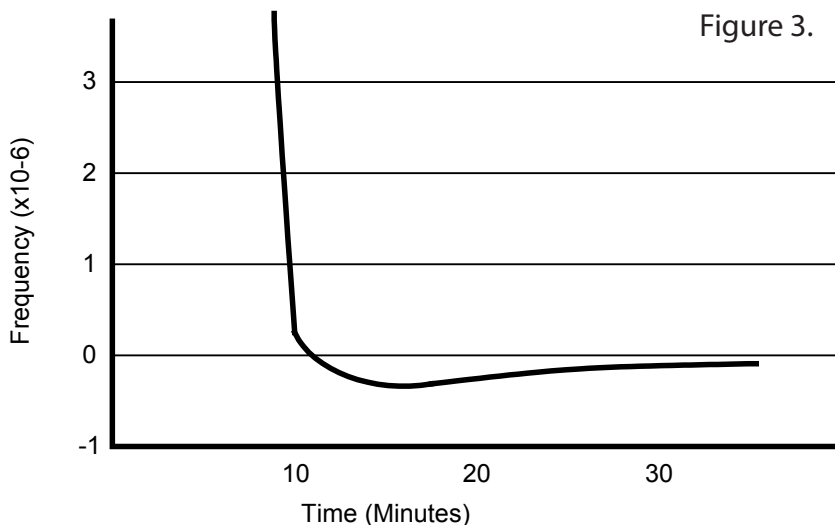

## Turnover Temperature

The oven operating temperature (crystal turnover temperature) must be several degrees higher than the highest ambient temperature in which the oscillator is to operate in order that the oven may maintain good control (considering the internal heat rise generated by the oscillator itself).

However, there are disadvantages associated with high oven temperature operation. First, the crystal's frequency vs. temperature characteristic is sharper with higher turnover crystals resulting in more sensitivity to minute changes in oven temperature as shown in Figure 4.

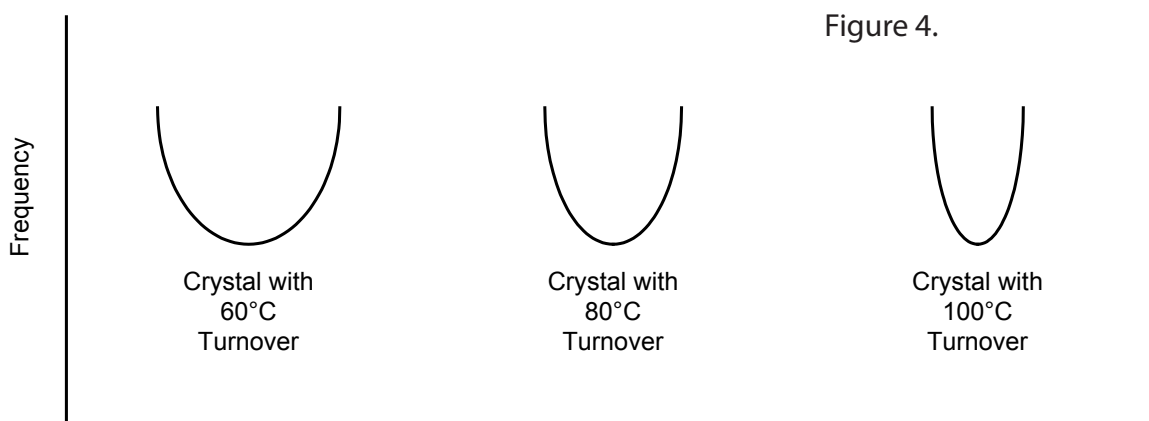

Second, and more important, crystal aging (discussed below) degrades with an increasing temperature. Therefore, in designing an oven controlled crystal oscillator, one is faced with a compromise in determining the desired oven operating temperature; it should be low as practicable, but it must be high enough to provide good control at the maximum ambient operating temperature.

## Stability

A. Aging - Aging refers to the continuous change in crystal oscillator frequency with time, all other parameters held constant. Prior to delivery, each Vectron oven controlled oscillator is pre-aged until it achieves its specified aging rate. Aging rate is often used synonymously with the word stability; thus, an oscillator with an aging rate of one part in  $10^{-8}$  per day ( $1 \times 10^{-8}/\text{day}$ ) is sometimes referred to as one part in 108 oscillator. This is incorrect terminology, as aging rate (long term stability) must be referred to time, and represents only one facet of oscillator stability.

B. Temperature Stability - As previously noted, because no oven control system is perfect, a change in ambient temperature causes a small change output frequency. The frequency shift is an offset from the oscillator's aging curve. This deviation from the normal aging characteristic is not related to time, but is a fixed offset. Thus, the frequency offset vs. temperature (temperature stability), for a given temperature change is, for example,  $5 \times 10^{-9}$ , not  $5 \times 10^{-9}/\text{day}$ . This characteristic is shown below.

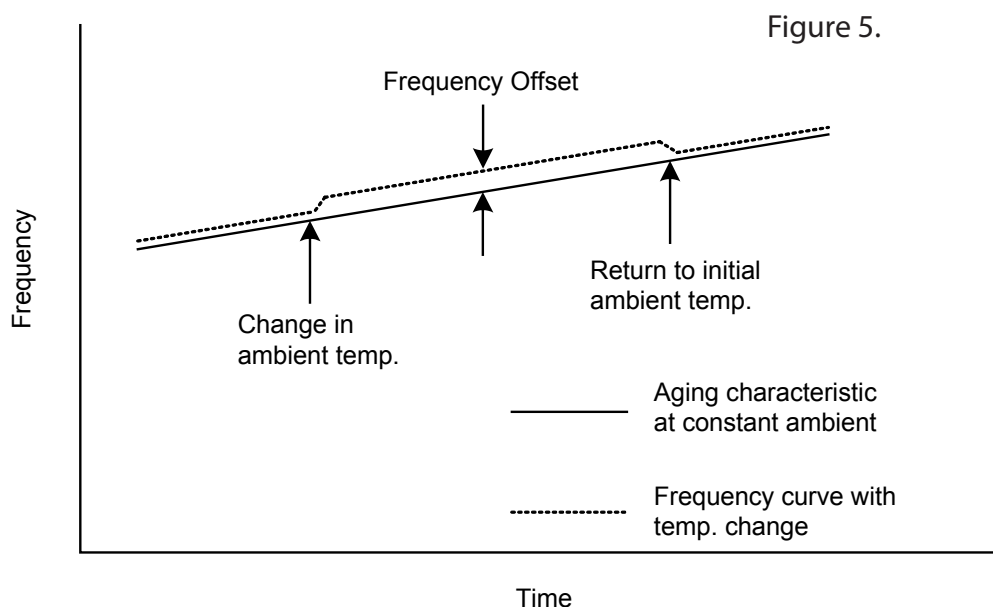

Ambient temperature changes do not produce hysteresis effects; that is, if there is a change in ambient temperature followed by a return to the original temperature, the final frequency will be essentially that which would have resulted had there been no ambient temperature change.

When the required temperature stability is beyond that which can be achieved with a standard proportionally controlled oven, a double oven system can be employed in which the standard oven is housed within a second oven. The outer oven then buffers the ambient temperature changes to the inner oven, which contains the oscillator circuit.

C. Restabilization And Retrace - When a crystal oscillator is turned off for a period of time and then turned on again (as occurs when the unit is shipped), the crystal requires a restabilization period. The characteristic is similar to the initial factory aging characteristic, but high stability is achieved significantly more quickly because the crystal has been factory pre-aged.

In most applications, oven-controlled crystal oscillators are continuously energized. This being the case, aging is the critical characteristic with turn-off/turn-on characteristic being of little or no significance. However, certain applications require that oven controlled crystal oscillators be frequently deenergized and re-energized (a practice which should be avoided whenever possible). When applications require frequent turn-off, an additional series of characteristics should be considered.

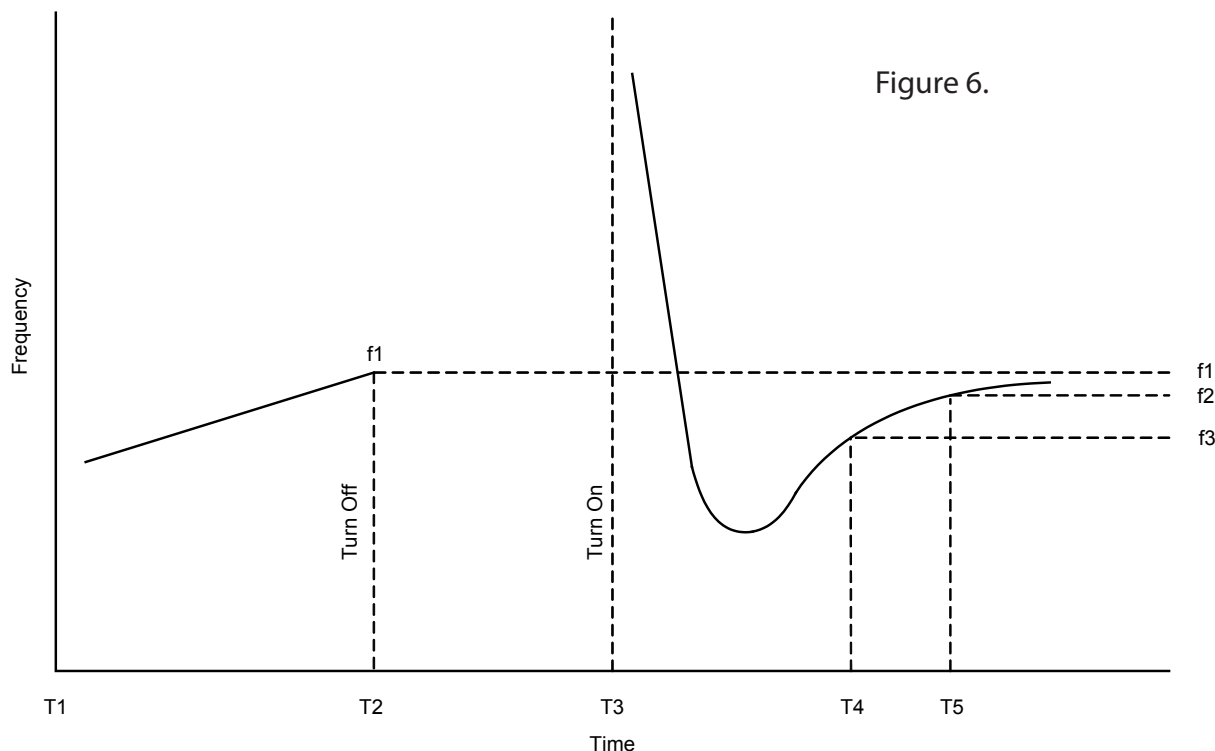

In Figure 6, assume that an oscillator is energized until time T2 when it is turned off for a period of time and then turned on again at time T3. Three characteristics may then be of significance:

1. How close does the oscillator return to the output frequency at turn-off, a specified time after turnon. This is called the retrace characteristic. Retrace error at T4 =  $f1 - f3$ .
2. How much will the frequency change over moderate periods of time (hours) after the oven has stabilized. This is called the restabilization, or warmup, characteristic. Restabilization rate from T4 to T5 =  $(f3 - f2) / (T5 - T4)$
3. How long does it take the oscillator to achieve its specified aging rate following a specified off period (This is called "reaging").

Many factors affect retrace, restabilization and reaging characteristics. Proper circuit design and component selection minimize their effects, leaving (1) the crystal and, (2) the length of off-period prior to oscillator turn-on as the prime factors. There is significant variation in these characteristics from crystal to crystal and they should only be specified when absolutely required and then only to the degree needed, as "tight" specifications in this area can have a major impact upon oscillator cost due to low yield. These characteristics are of little consequence in oscillators which are energized continuously.

## Double Rotated (SC and IT Cut) Crystals

While most high stability crystal oscillators use AT Cut Crystals, SC and IT Cut Crystals are often used in the highest stability models.

An SC Cut Crystal is one of a family of double rotated crystals (quartz crystals cut on an angle relative to two of the three crystallographic axes). Others in the family include the IT Cut and FC Cut. The SC Cut represents the optimum double rotated design as its particular angle provides maximum stress compensation, but similar performance is achieved with the IT Cut.

Following is a comparison between double rotated (referred to simply as SC for convenience) and AT Cut crystals.

### Advantage of SC Crystals:

1. Improved Aging. For a given frequency and overtone (e.g. 10 MHz, third overtone), the SC crystal provides 2:1 to 3:1 aging improvement relative to AT crystals.
2. Warm-up. In oven controlled oscillators with a given oven design and turn-on power, the SC crystal achieves its "final frequency" in considerably less time than does the AT crystal.
3. Phase Noise. For a given oscillator design, crystal frequency and overtone, the SC crystal provides higher Q and associated improved phase noise characteristics. This improvement applies primarily close to the carrier as the noise floor is determined by circuit design rather than the crystal.
4. High Operating Ambient Temperature. Figure 7 shows the relative frequency-temperature characteristics of AT, IT and SC crystals. The upper temperature turnover point of the AT crystal ("A" in Figure 7) and lower temperature turnover point of the SC crystal ("B" in Figure 7) are optimally in

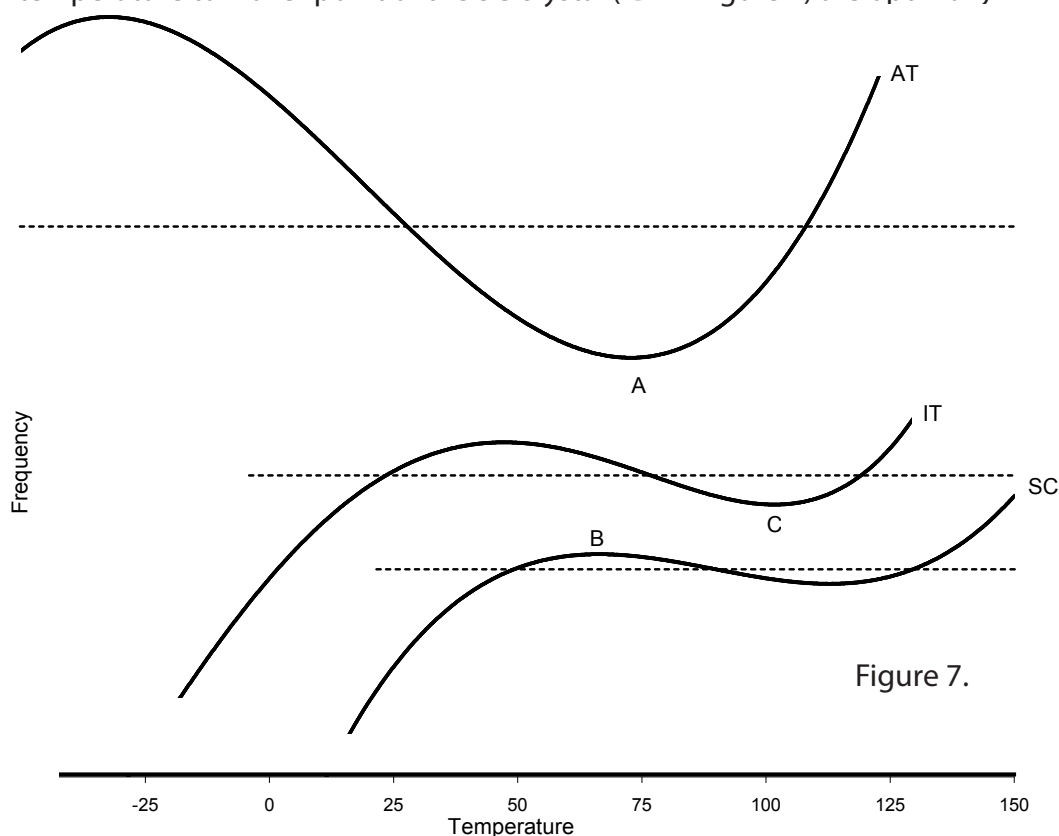

Figure 7.

the 70°C to 90°C temperature range. Based upon (a) the desired 10°C difference between the highest operating ambient temperature and the crystal turnover temperature, and (b) the manufacturing tolerance of crystal turnover temperatures, these crystals are best suited for maximum operating ambient temperatures of 50°C to 75°C. However, the upper temperature turnover point of the IT crystal (“C” in Figure 7) is well suited to higher temperature operation and thus the IT crystal is a logical choice for high stability oven controlled oscillators having a maximum operating temperature in the 85°C to 95°C range. Note that while SC and IT crystal curves are relatively flat at elevated temperatures, their frequency falls off rapidly at low temperatures. Thus, while they serve well in high stability HIF oven controlled oscillators, they are generally not well suited for other types of stable crystal oscillators.

5. Orientation Sensitivity (tip-over). When the physical orientation of an oscillator is changed, there is a small frequency change (typically not more than several parts in  $10^{-9}$  for any 90 degree rotation), due to the change in stress on the crystal blank resulting from the gravitational affect upon the crystal supports. Tip-over is expressed in  $10^{-9}/g$  where one g represents one half of a 180° orientation change. The SC crystal is less frequency sensitive to orientation change than is the AT. However, the tip-over difference between AT and SC crystals is not consequential for most applications and this characteristic is usually not a specification consideration.

6. Spurious Under Vibration. When a crystal oscillator is subjected to vibration, spurious frequencies are generated, offset from the frequency oscillation by the frequency of vibration. The amplitude of these spurious outputs is related to the amplitude of vibration, the mechanical design of the crystal support, and the mechanical design of the oscillator. The SC crystal produces lower amplitude spurious output under vibration than does the AT; however, this characteristic is determined more by the mechanical designs of the crystal and oscillator than by crystal cut.

## Disadvantages of SC Crystals:

1. Cost. Because of difficulties associated with tightly-controlled angle rotations around two axes in the manufacture of SC crystals vs one axis for the AT, the SC crystal is significantly higher in cost than that of an AT of the same frequency and overtone.

2. Pullability. The motional capacitance of an SC crystal is several times less than that of an AT of the same frequency and overtone, thus reducing the ability to “pull” the crystal frequency. This restricts the SC crystal from being used in conventional TCXOs and VCXOs, or even in oven controlled oscillators requiring the ability to deviate the frequency of oscillation by any significant degree.

In summary, the suitability of double rotated crystals for use in crystal oscillators is essentially restricted to those oven controlled applications where the improved aging, warm-up, and close-in phase noise characteristics justify a significant cost increase.

### For Additional Information, Please Contact

#### USA:

Vectron International  
267 Lowell Road  
Hudson, NH 03051  
Tel: 1.888.328.7661  
Fax: 1.888.329.8328

#### Europe:

Vectron International  
Landstrasse, D-74924  
Neckarbischofsheim, Germany  
Tel: +49 (0) 7268.8010  
Fax: +49 (0) 7268.801281

#### Asia:

Vectron International  
1589 Century Avenue, the 19th Floor  
Chamtime International Financial Center  
Shanghai, China  
Tel: +86 21 6081.2888  
Fax: +86 21 6163.3598

#### Disclaimer

Vectron International reserves the right to make changes to the product(s) and or information contained herein without notice. No liability is assumed as a result of their use or application. No rights under any patent accompany the sale of any such product(s) or information.