

Helping Customers Innovate, Improve & Grow



## Features

- Ultra low Phase Noise
- Ultra low G-Sensitivity
- Vibration hardened
- Tight Tolerances
- Frequency Range 60 - 120MHz
- Standard Frequency 120MHz

## Applications

- Vibration Environment
- Airborne and Military Equipment
- Portable Equipment
- Radar

## Performance Specifications

Frequency Stabilities <sup>1</sup>						
Parameter	Min	Typical	Max	Units	Condition	Options <sup>3</sup>
vs. operating temperature range (referenced to nominal frequency)	-15.0		+15.0	ppm	-20 to +70°C	
	-25.0		+25.0	ppm	-40 to +85°C	
Initial tolerance	-15.0		+15.0	ppm	25°C V <sub>s</sub> ±5% static Load ±10% static after 30 days of operation after 30 days of operation	
vs. supply voltage change	-0.1		+0.1	ppm		
vs. load change	-0.1		+0.1	ppm		
vs. aging / 1 year	-1.0		+1.0	ppm		
vs. aging / 10 years	-3.0		+3.0	ppm		

## Performance Specifications

Supply Voltage (Vs)						
Parameter	Min	Typical	Max	Units	Condition	
Supply voltage (standard)	14.25	15	15.75	VDC		
Current consumption			100	mA		
RF Output						
Signal [standard]	Sinewave				50 Ω load	
Load	45	50	55	Ohm		
Output Power	10	13	16	dBm	50 Ω load	
Harmonics			-30	dBc	50 Ω load	
Spurious			-80	dBc	50 Ω load	
Additional Parameters						
Phase Noise <sup>2</sup>		-90		dBc/Hz	10 Hz	@ 120 MHz 13 dBm sinewave no vibration
		-125		dBc/Hz	100 Hz	
		-153		dBc/Hz	1 kHz	
		-167		dBc/Hz	10 kHz	
		-173		dBc/Hz	100 kHz	
	-175		dBc/Hz	1 MHz		
G-Sensitivity		0.5		ppb/g	without shock absorbers <sup>3</sup>	
Weight		55	75	g		
Processing & Packing	Handling & Processing Note					
Additional Environmental Conditions						
Random Vibration	MIL-STD-202G; Method 214A; Cond H					
Shock	MIL-STD-202G; Method 213B; 15 g / 20 ms (for softest shock absorber i.e. lowest resonance frequency)					
Solderability	JEDEC J-STD-002: non RoHS compliant					
Solvent Resistance	non-washable device					
Absolute Maximum Ratings						
Supply voltage (Vs)			16.0	V		
Output Load	45		55	Ω		
Operable Temperature Range	-40		+85	°C		
Storage Temperature Range	-40		+105	°C		

## Outline Drawing / Enclosure

Parameter	Min	Typical	Max	Units	Condition
G295 including vibration isolators. Mechanical resonance frequency	35		110	Hz	Please specify vibration profile and phase noise max values under vibration

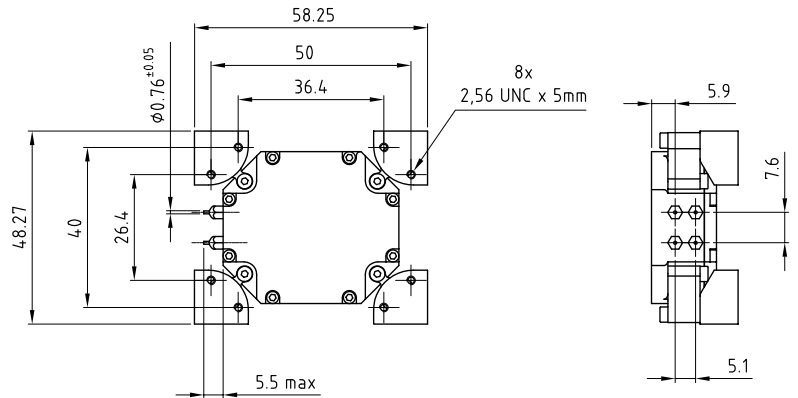
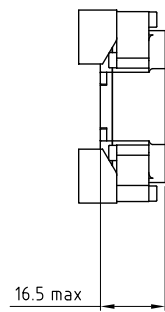
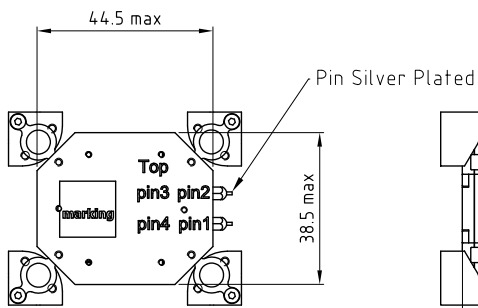
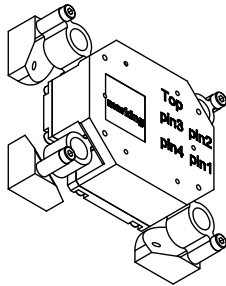
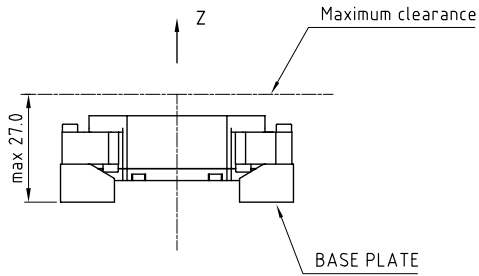

Dimensions in mm

Pin Connections	
1	N.C.
2	Supply Voltage (Vs)
3	RF-Output
4	Ground (Case)

## Housing Options

Parameter	Note
G295 Standard with vibration isolators	Option please specify vibration profile and phase noise max values under vibration
G313 without vibration isolators	Option please specify vibration profile and phase noise max values under vibration

**Note:** Customized housings are possible. Please specify housing and vibration profile and phase noise max values under vibration

## Typical Phase Noise @ 120 MHz without vibration

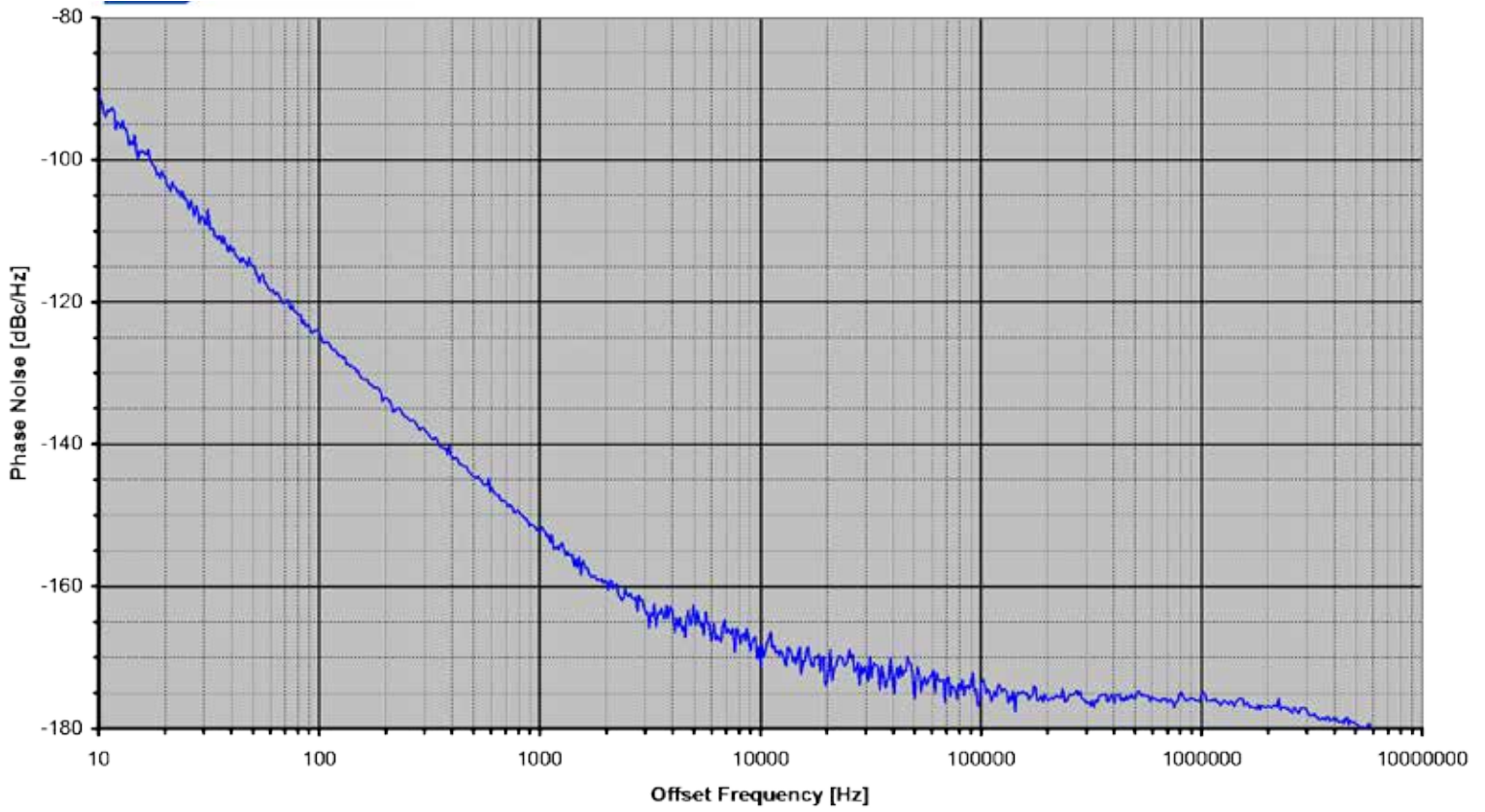

## Typical Frequency Stability vs Temperature

### Frequency and Pout vs. Temperature

Specification:	PX-990-0001	29.11.2010
Frequency:	120,000 MHz	
Osc.-No.:	SN1	

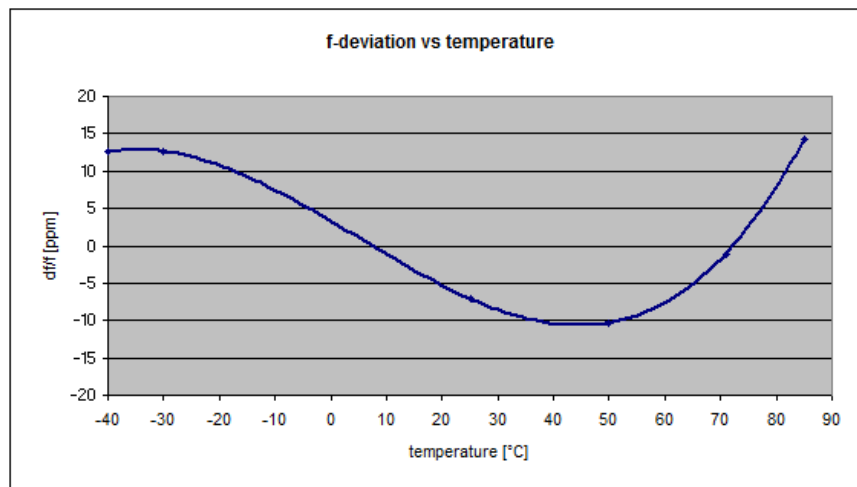

# Typical G-Sensitivity @120 MHz without shock absorber

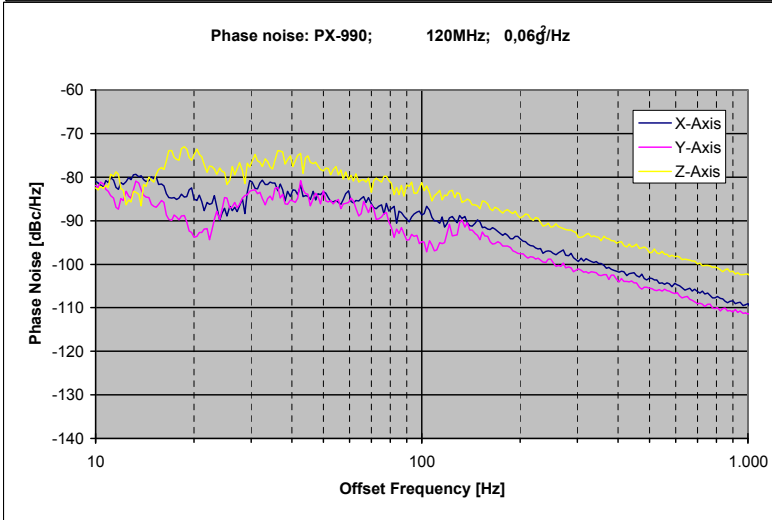
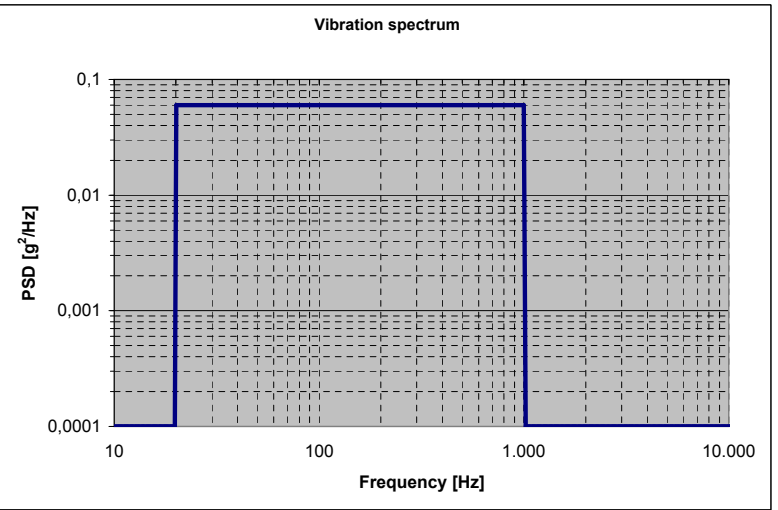
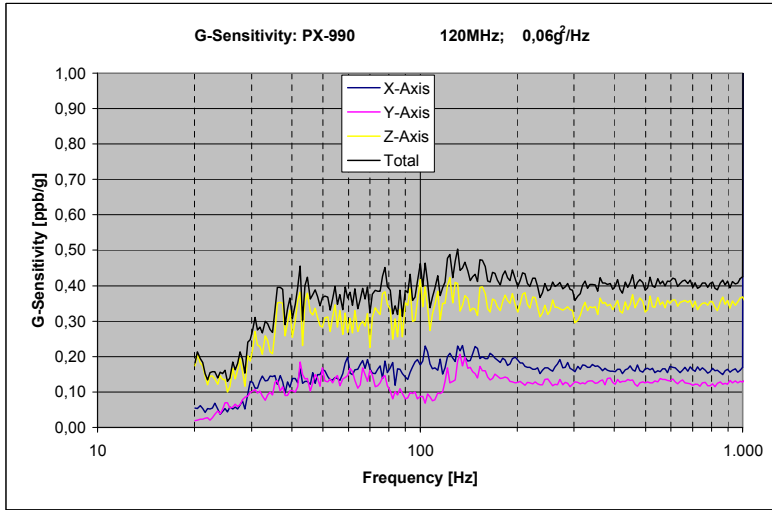

Calculation equation according to Vig-Tutorial

g-sensitivity: 
$$G = \frac{2 \cdot f_v}{A_{peak} \cdot f_0} \cdot 10^{\frac{L(f)}{20}}$$

Peak g-level: 
$$A_{peak} = \sqrt{PSD \cdot 2}$$

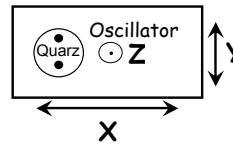

**Notes:**

1. Contact factory for improved stabilities or additional product options. Not all options and codes are available at all frequencies.
2. Phase noise degrades with increasing output frequency.
3. Contact factory for availability.

Unless other stated all values are valid after warm-up time and refer to typical conditions for supply voltage, frequency control voltage, load, temperature (25°C).

Subject to technical modification.

# Typical Phase Noise @ 120 MHz with vibration

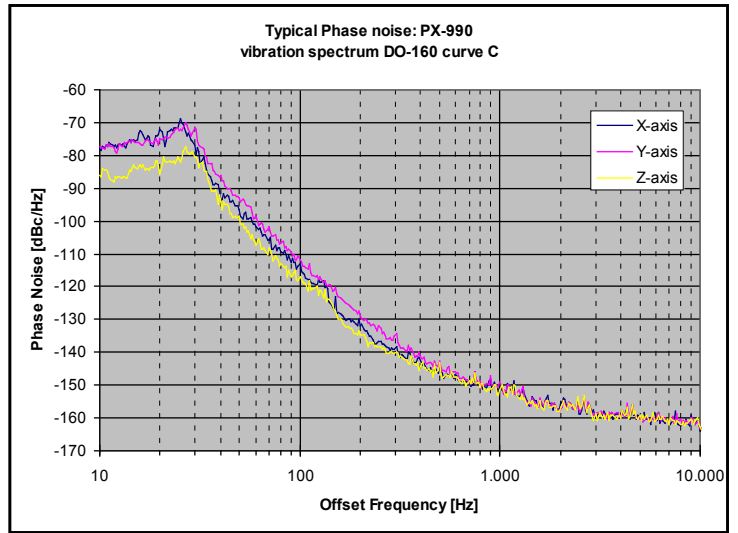
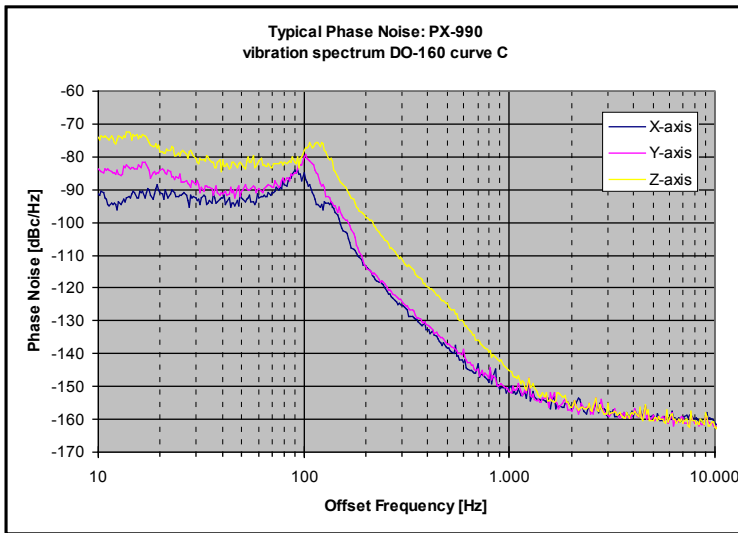
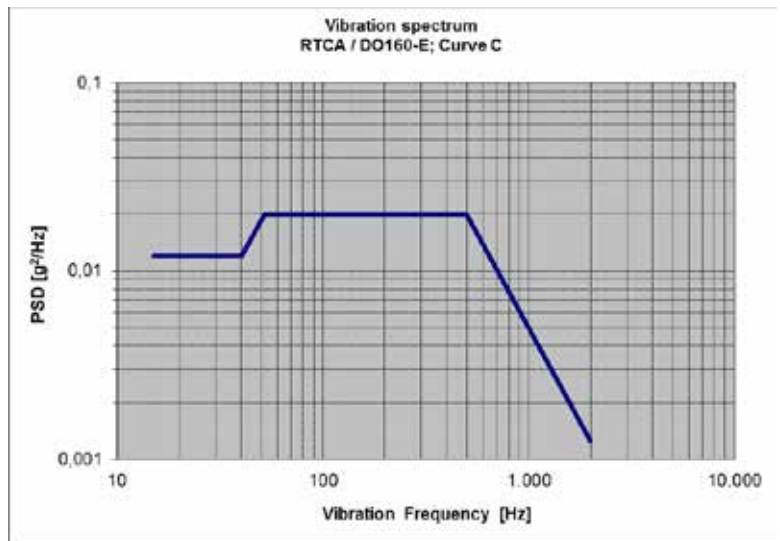
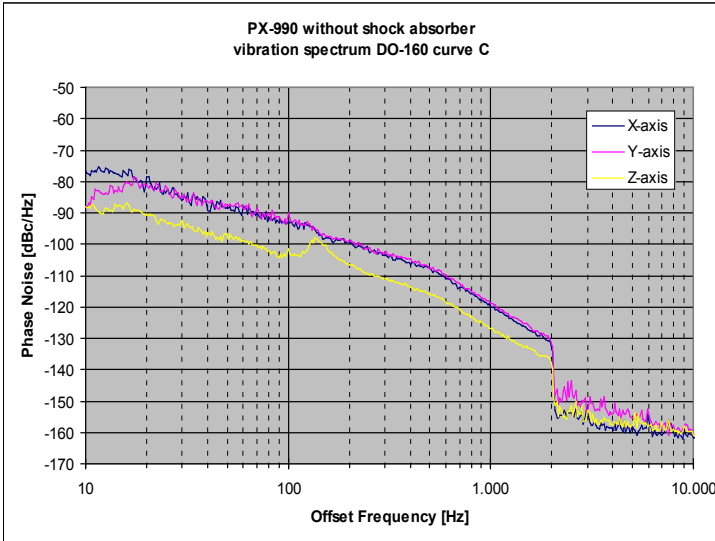

## Ordering Information

**All Oscillators from the 990s Product Group are Customized. Please include your complete specification, including vibration profile and required phase noise and phase noise under vibration to your inquiry.**



Microsemi Headquarters  
One Solaropole, 4800 Via, CA 92056 USA  
Within the USA: +1 (800) 713-4433  
Outside the USA: +1 (949) 360-0100  
Fax: +1 (949) 360-0130  
email: sales.support@microsemi.com  
www.microsemi.com

Microsemi, a wholly owned subsidiary of Microchip Technology Inc. (NASDAQ: MCHP), offers a comprehensive portfolio of semiconductor and system solutions for aerospace & defense, communications, data center and industrial markets. Products include high-performance and radiation hardened analog, mixed-signal, integrated circuits, FPGAs, DDCs and ASICs, power management products, timing and synchronization devices, and precision time solutions, serving the world's neediest for space, space, precision, services, RF, robotics, defense, components, ultrasonic, storage, and communications solutions, security technologies and scalable with temper products, Ethernet solutions, Power-over-Ethernet ICs and midspans, as well as custom design capabilities and services. Learn more at [www.microsemi.com](http://www.microsemi.com).

Microsemi makes no warranty, representation, or guarantee regarding the information contained herein or the suitability of its products and services for any particular purpose, nor does Microsemi assume any liability whatsoever arising out of the application or use of any product or service. The products and services and any other products sold by Microsemi have been subject to limited testing and should not be used in production with mission-critical equipment or applications. Any performance specifications are believed to be reliable but are not certified, and should not be used to complete all performance and other testing of the product, device and/or system with or without it, and products should not be used for any data and performance specifications or parameters provided by Microsemi, or the buyer's responsibility of independently determine suitability of any products and/or services used for the same. The information provided by Microsemi is provided "as is, where is" and with all faults, and the user risk associated with such information is solely with the Buyer. Microsemi does not grant, explicitly or implicitly, in any way any patent rights, licenses, or any other intellectual property rights with respect to such information itself or anything derived from such information. Information provided in this document is proprietary to Microsemi, and Microsemi reserves the right to make any changes to the information in this document, in its products and services, at any time without notice.  
©2018 Microsemi, a wholly owned subsidiary of Microchip Technology Inc. All rights reserved. Microsemi and the Microsemi logo are registered trademarks of Microsemi Corporation. All other trademarks and service marks are the property of their respective owners.